

VERA SOLO



VERA SOLO

VERA SOLO ingår i parkserien VERA som är designad för alla tänkbara miljöer. Vera Solo är speciellt lämplig för miljöer där man önskar sittytter från två sidor och bänken passar lika bra på välbesökta torg och gator som på stationer, flygplatser och bussterminaler.

Bänken finns i rak och svängd standardlängd, men också i moduler som kan kombineras ihop, i raka eller slingrande former, alternativt för placering i cirkel exempelvis runt ett träd.

Designen underlättar renhållning omkring bänken. Välj mellan en sits i trä, träersättning eller rundstål. Bord kan också väljas till i samma material och färg som bänken.

VERA SOLO

MATERIAL & UTFÖRANDE

Stomme: Stål. Förzinkat och pulverlackerat.
Sits: Jatoba (FSC-certifierad), Resysta träersättning,
Linaximpregnerad svensk furu, Rundstål, Rostfritt stål.
Bordsstomme: Stål. Förzinkat och pulverlackerat.
Bordsskiva (ribbor): Jatoba, Resysta träersättning,
Linaximpregnerad svensk furu.

FÄRG
Färgkod B

MÅTT

Längd: Bänk (rak) 1815 mm
Bredd: 500 mm
Sithöjd: 450 mm

VARIANT

Bänk (rak/svängd), Bänk med sitsavdelare
Bord

FASTSÄTTNING

Fastbultning

TILLBEHÖR (ingår ej):

Nedgrävningsfundament för mmcité-soffor.

DESIGN

David Karásek, Radek Hegmon

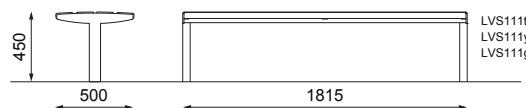
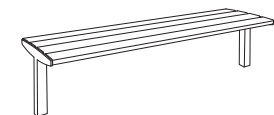

Sits:
t - Jatoba trä
y - Resysta träersättning
g - Linaximpregnerad furu (Royalimpregnerad)
n - Rostfritt stål

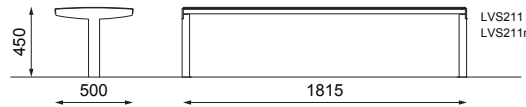
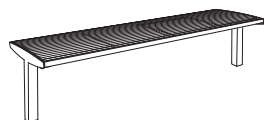
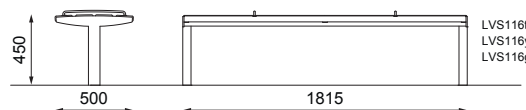
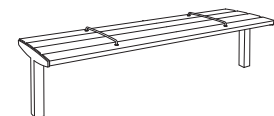

Vera Solo bord

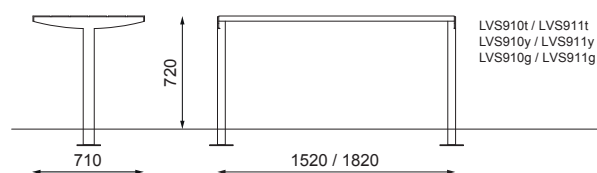
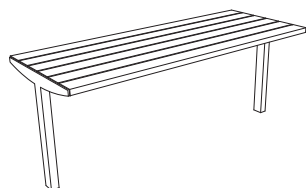

VERA SOLO

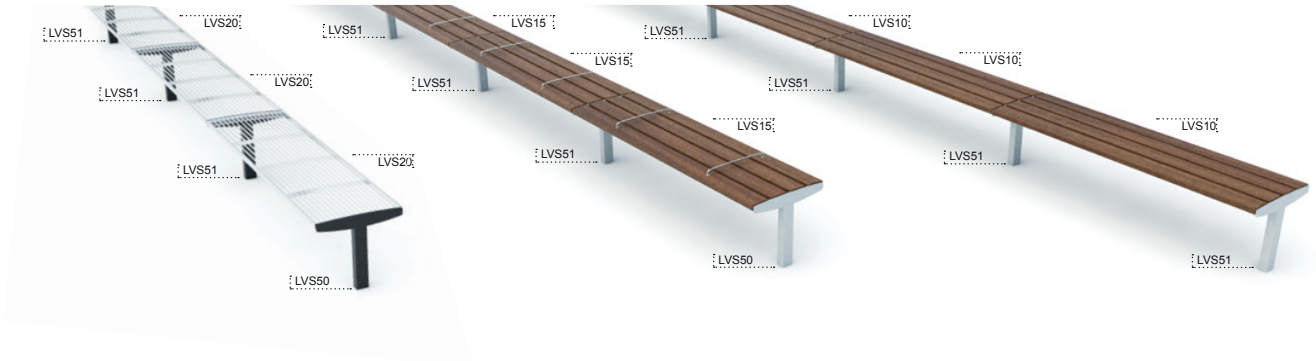

LVS50



LVS51

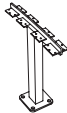

LVS10t
LVS10y
LVS10g

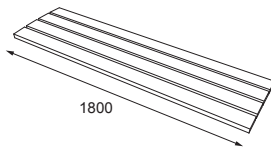

LVS15t
LVS15y
LVS15g

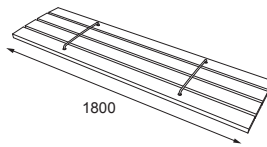

LVS20
LVS20n

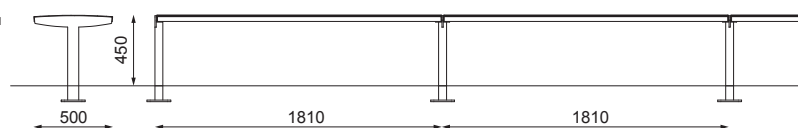
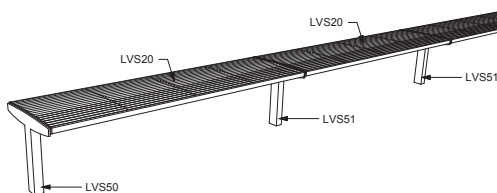
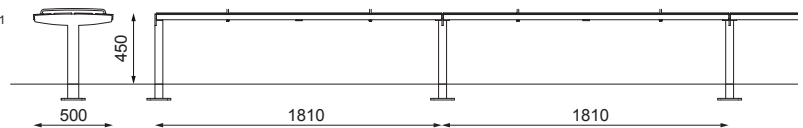
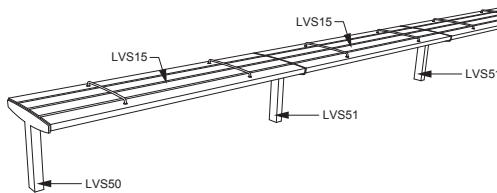
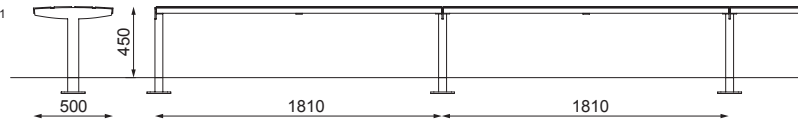
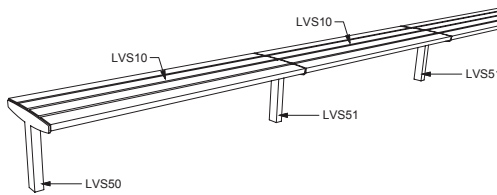
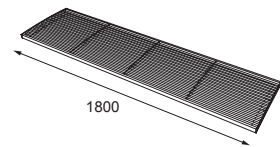

VERA SOLO

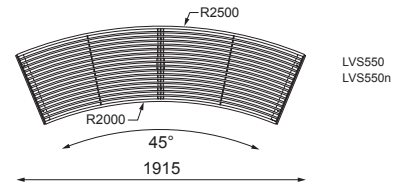
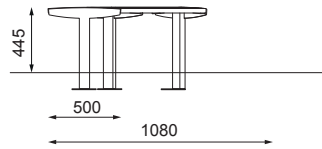
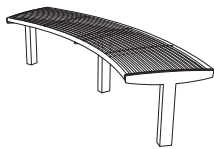
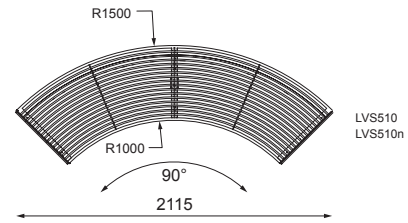
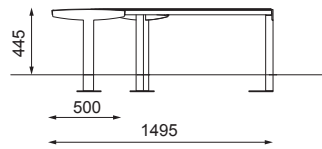
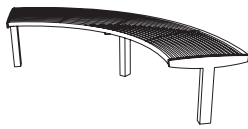
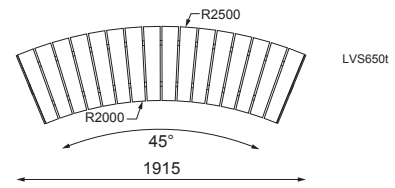
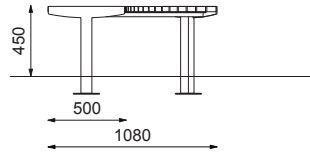
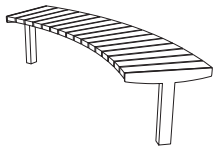
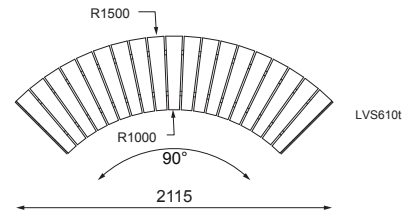
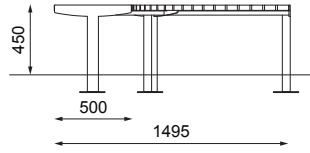
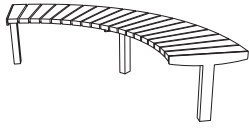

VERA SOLO

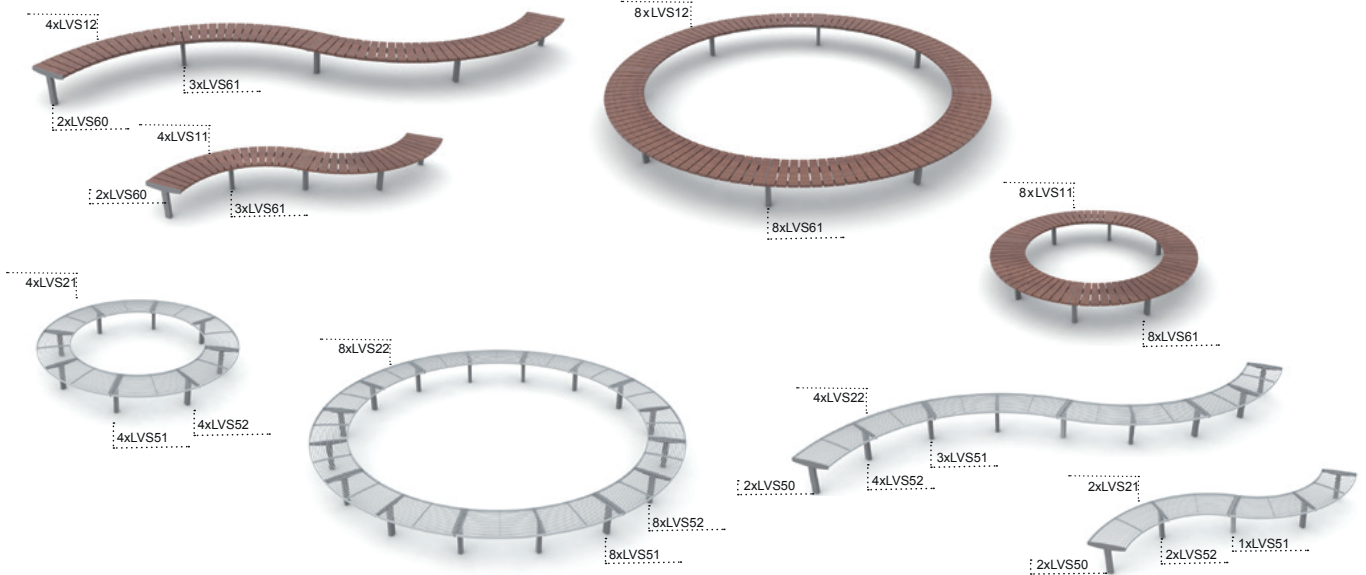

LVS60



LVS61



LVS11t

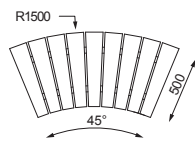

LVS12t

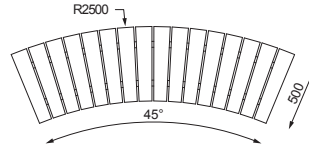

LVS50



LVS51

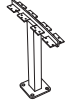

LVS52



LVS21
LVS21n

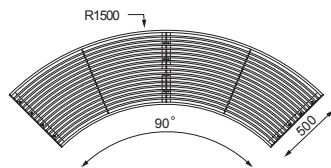

LVS22
LVS22n

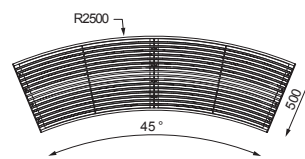

Monteringsanvisning

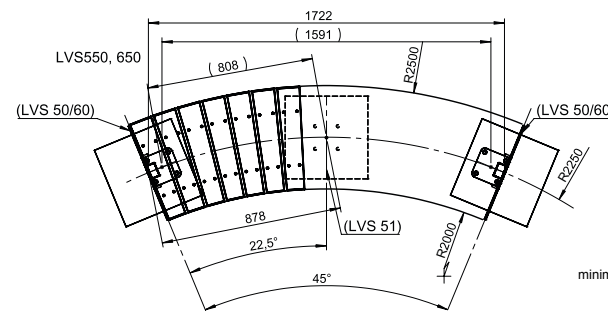
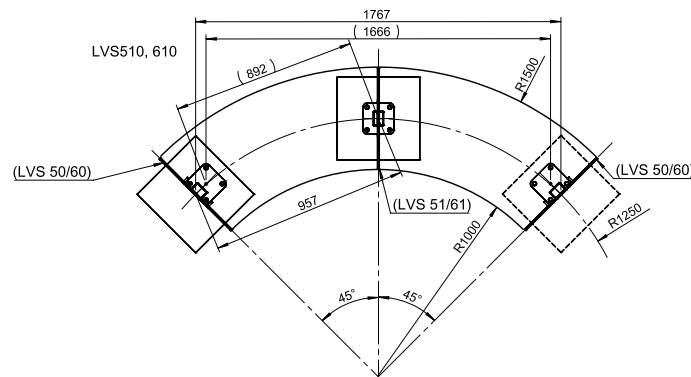
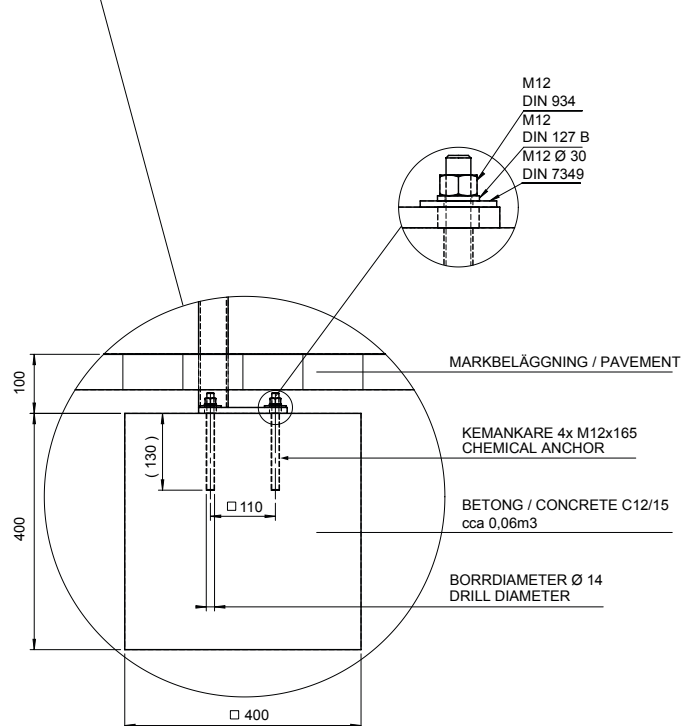
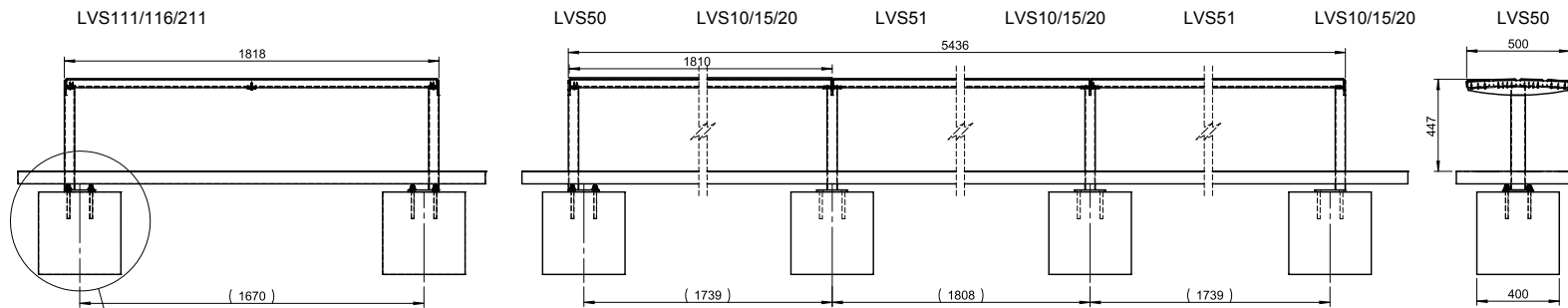

minimal load-bearing capacity of the soil 150kPa
dimensions in mm

77900100
v.2016.09.29 CH

1 / 1

VERA SOLO - BORD

Monteringsanvisning

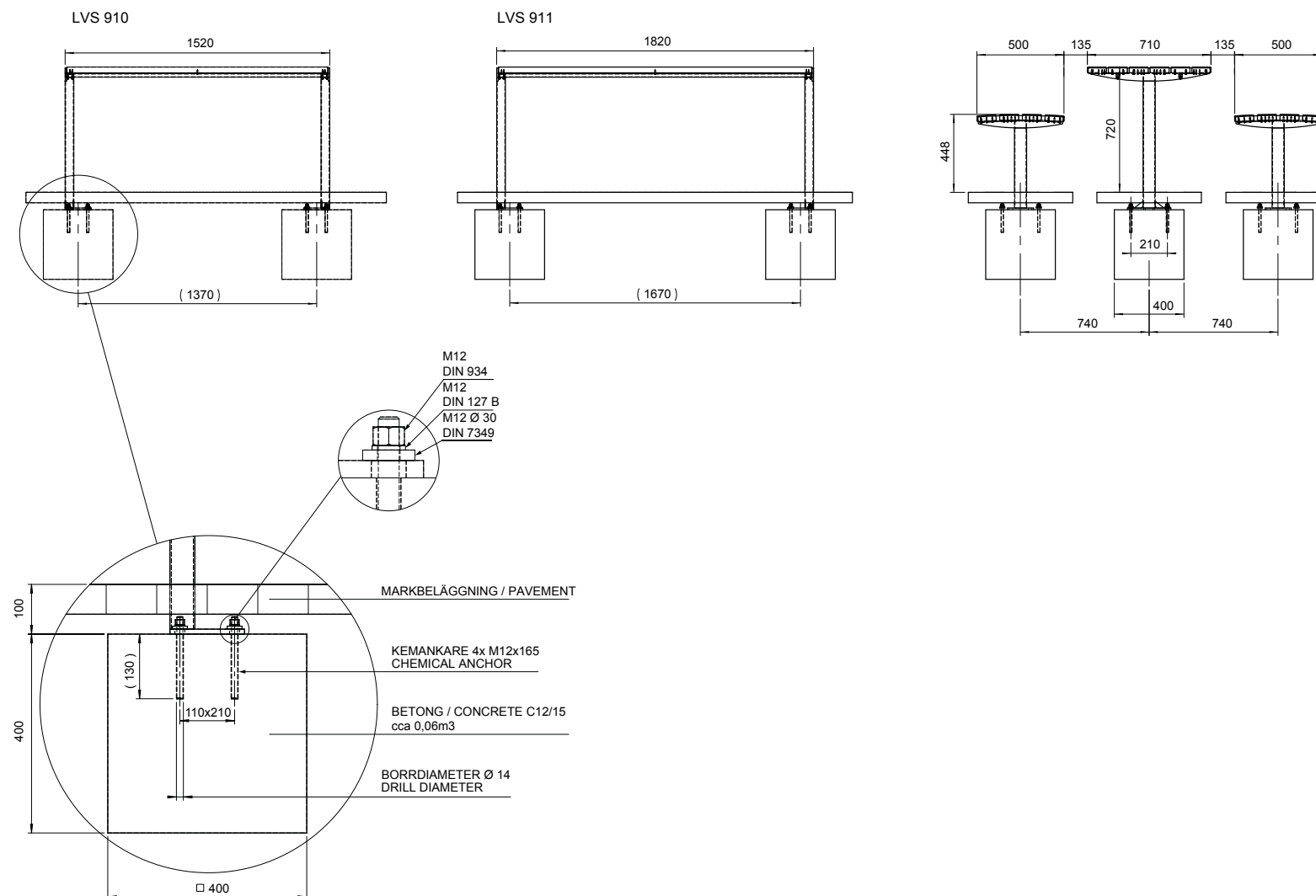

77900123
v.2016.09.29 CH

1 / 1